

### ■ Features

- Input voltage: 90-305VAC
- Built-in active PFC function: 0.99 Typ.
- Low THD: 10% Typ.
- High efficiency: 93% Typ.
- IP67 design for indoor or outdoor installations.
- High surge immunity
- Support Time-shared dimming function
- Compliance to worldwide safety regulations for lighting.
- Suitable for dry/damp/wet locations.
- 5 Years Warranty.



### ■ Specification

Model		035	045	053	070	105	140	175	210	245	280	315	350	420	500	
(MU150AXXXAQ_CLK)																
Input	Efficiency (Typ.)110VAC	90.0%	90.0%	90.0%	90.0%	89.0%	89.0%	89.0%	89.0%	89.0%	89.0%	88.0%	88.0%	88.0%	88.0%	
	Efficiency (Typ.)220VAC	93.0%	93.0%	93.0%	93.0%	92.0%	92.0%	92.0%	92.0%	92.0%	92.0%	91.0%	91.0%	91.0%	91.0%	
	Voltage Range (VAC)	90-305														
	Frequency Range (Hz)	47-63														
	Power Factor(Typ.)	0.99 (Typical) , >0.90 at 100~277VAC input, 70%~100% load														
	THD(Typ.)	<10% at 220VAC input 50Hz, 70%~100% load, <15% at 110VAC and 277VAC input 60Hz, 70%~100% load,														
	AC Current(MAX.)	1.8A at 110VAC , 0.9A MAX at 220VAC														
	Inrush Current(MAX.)	65A (25°C , at 230VAC , cold start)														
	Leakage Current(MAX.)	1mA at 277VAC 50Hz input														
Output	DC Voltage (V)	428	333	283	214	142	107	85	71	61	53	48	42	36	30	
	Rated Current(mA)	350	450	530	700	1050	1400	1750	2100	2450	2800	3150	3500	4200	5000	
	Rated Power (W)	149.8	149.9	150.0	149.8	149.1	149.8	148.8	149.1	149.5	148.4	151.2	147.0	151.2	150.0	
	Ripple&Noise (Vp-p)	12.84	9.99	8.49	6.42	4.26	3.21	2.55	2.13	1.83	1.59	1.44	1.26	1.08	0.9	
	Voltage ADJ. Range(V)	214~428	167~333	142~283	107~214	71~142	54~107	43~85	36~71	31~61	27~53	24~48	21~42	18~36	15~30	
	Current Tolerance <sup>Note.1</sup>	±5%	±5%	±5%	±5%	±5%	±5%	±5%	±5%	±5%	±5%	±5%	±5%	±5%	±5%	±5%
	Line Regulation	±1%	±1%	±1%	±1%	±1%	±1%	±1%	±1%	±1%	±1%	±1%	±1%	±1%	±1%	±1%
	Load Regulation	±3%	±3%	±3%	±3%	±3%	±3%	±3%	±3%	±3%	±3%	±3%	±3%	±3%	±3%	±3%
	Setup, Rise Time	1.2s max, measured at 120VAC input; 1s max, measured at 220VAC input														
	Hold Up Time	10ms at 220VAC 100% load														
Protection	Over Voltage(V)(Typ.)	556	433	382	278	185	139	111	92	79	69	62	55	47	39	
	Short Circuit	Hiccup mode. The power supply shall be self-recovery when the fault is removed.														
	Over Temperature	Protection type : Decrease output current . When TC reaches 110±10°C , the output current decrease to 50% rate value until the TC reaches 75±10°C														
Environment	Working Temp.	-40~+70°C, refer to the derating curve for detail														
	Working Humidity	5~100%RH, non-condensing														
	Storage Temp., Humidity	-40~+85°C , 5%-100%RH														
	Temp. Coefficient	0.03%/°C ( 0~50°C )														
Vibration	10-500Hz, 5G 12min/cycle, period for 72min each along X、Y、Z axes															
Safety & EMC	Safety Standard	UL8750, UL1012, CAN/CSA-C22.2No.107.1-01,EN61347-1, EN61347-2-13														
	Withstand Voltage	I/P-O/P:3.75KVAC I/P-FG:1.875KV O/P-FG:1.5KV														
	Isolation Resistance	I/P-O/P ,I/P-FG,O/P-FG:100M Ohms/500VDC/25°C/70%RH														
	EMC Emission	EN55015/FCC Part 15 Class B , EN61000-3-2 Class C , EN61000-3-3														
EMC Immunity	EN61000-4-2,3,4,5,6,8,11 , EN61547 ( Surge L,N-FG 6KV , L-N 4KV )															
Others	MTBF	300,000 hours, measured at full load, 25°C ambient temperature, 80% Load ,MIL-HDBK-217F														
	Dimension	221 x 67.5 x 40 mm (LxWxH)														
	Weight	1.05kg														

Note.1: Includes set up tolerance, line regulation and load regulation.

### Test Curve

#### Derating Curve

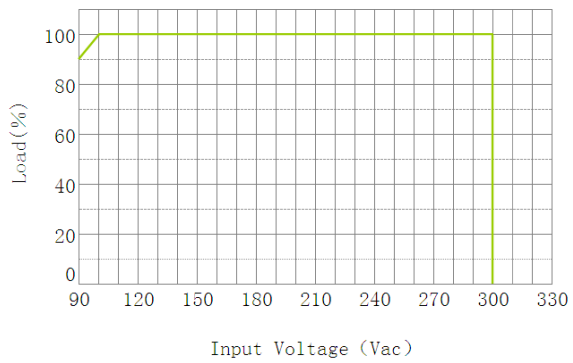
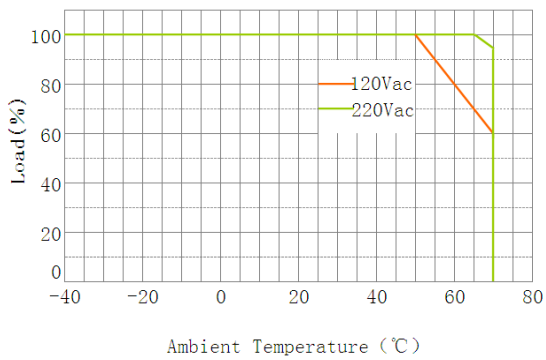

#### Power Factor Curve

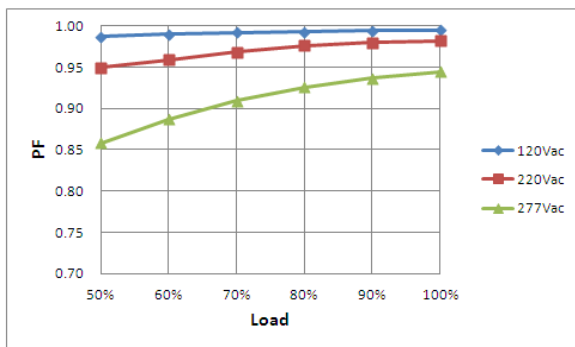

#### Efficiency VS. Load Curve(Model:700mA)

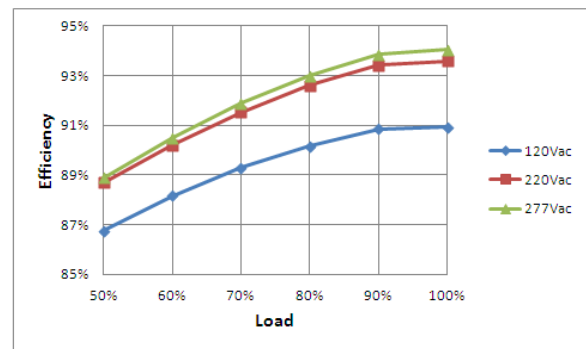

#### THD Curve

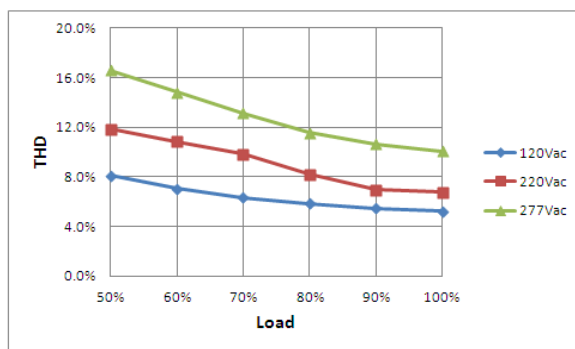

### ■ Instruction

#### 1.Field Programmable Topology

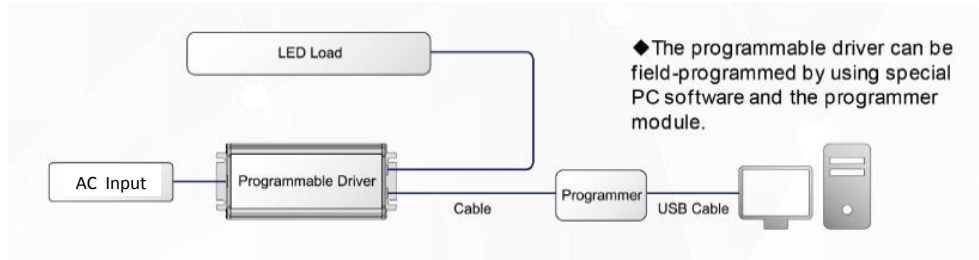

#### 2.Dimming Interface Description

Pin description

Pin	Name	Value	Description
1	VPP	4.5V~5.5V	Programming model enable (编程模式使能)
2	VDD	4.5V~5.5V	DC supply input (DC供电输入)
3	GND	0V	DC Ground (DC地)
4	ICSPDAT	4.5V~5.5V	Programming data (编程数据接口)
5	ICSPCLK	4.5V~5.5V	Programming clock (编程时钟接口)
6	0-10V	0~10.5V	0-10Vdc dimming signal

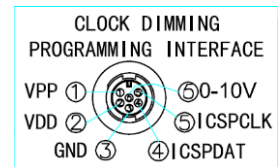

#### 3.Dimming Software Function Instruction

##### ■ Adjustable Output Current(AOC)

Adjustable Output Current (AOC)

Module Current  %

Users can set the rated current between 20%~100% by 1% per step.

##### ■ Adjustable Startup Time(AST)

Adjustable Startup Time (AST)

Start Fadeup Time  s

At power ON, the fast fade-up of light can be unpleasant in certain applications. To avoid such a situation, the driver fade-up time at start-up can be programmed to a value among 1s、2s、5s、10s、20s、40s. The default start fade up time is 1s

##### ■ Set Module Working Hrs

Set Module Working hrs (SMW)

Set Module Working hrs  hrs

Used to reset the working hour counting in the microcontroller of the driver and collaborate with CLO.

##### ■ PWM

Dimming Interface Selection (DIS)

1-10V  PWM  Integrated Dynadimmer  Integrated Dynadimmer Time Based  No Dimming

The driver will follow the PWM signal to dim, and the signal should be 0~5V, 500Hz~5KHz.

##### ■ 1-10V

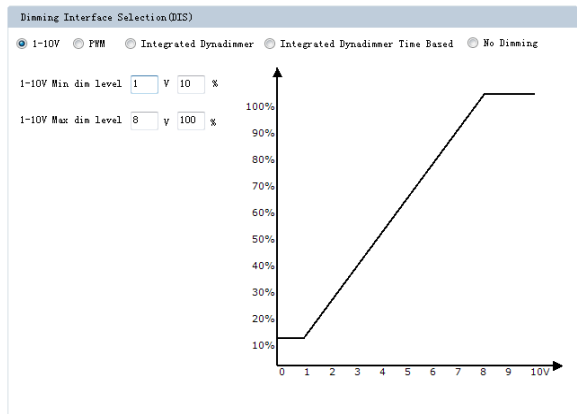

Allow users to set the max and min output current and corresponding output voltage to clarify the 1-10V dimming curve.

The working mode of programmable drivers can be interrupted by external input including PWM signal and 1-10V signal. PWM mode has a higher priority than 1-10V when the two kinds of external signal are enabled at the same time.

可编程电源工作在正常模式下是能够被输入外部输入模式打断的 (PWM输入 1-10V输入), 当同时存在两种外部输入模式时 PWM输入模式优先级更高

### ■ Instruction

#### ■ Integrated Dynadimmer

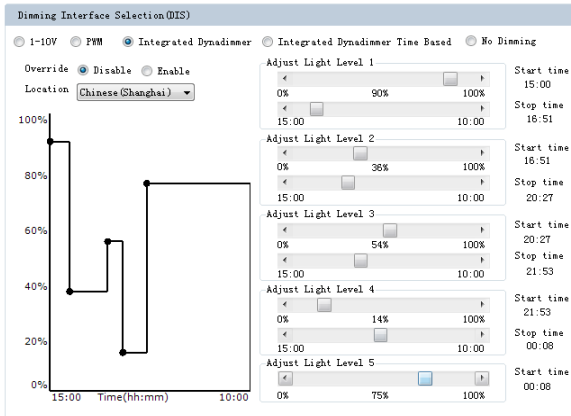

Using Integrated Dynadimmer, users can set 5 light levels and associated time frames. The driver does not have a real time clock. Instead it calculates a "virtual clock time," determined by the duration of operation of the driver in the night. After 3 valid "ON-times," the driver will be able to calculate the virtual clock time. A valid ON-time is defined as the time for which driver operates continuously for  $\geq 4$  hours and  $\leq 24$  hours. After learning driver ON-time for 3 consecutive days, the dim profile takes effect from the 4th day onwards. With flexibility in setting time and light levels, the user can configure the driver for specific locations and applications, and the light level may be reduced during non-peak hours.

#### ■ Constant Light Output(CLO)

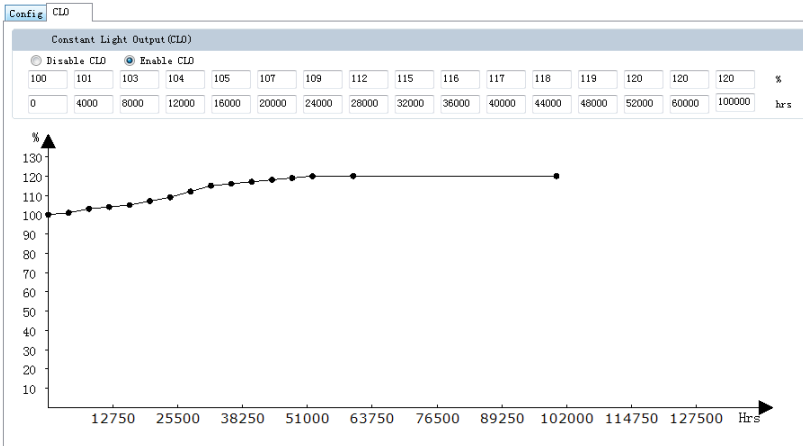

The CLO feature of the driver enables OEMs to create solutions with LEDs that deliver constant lumens through the life of the product. Based on the type of LEDs used, heat sinking and driver current, OEMs can estimate the depreciation of light output for specific LEDs and this information can be entered into the driver using the 16 point CLO interface. The driver counts the number of "LED module working hours." As shown in the following figure, each data point represents the LED module working hours threshold and the corresponding driver CLO percentage. The driver will increase current based on this input to enable CLO.

#### ■ Integrated Dynadimmer Time Based

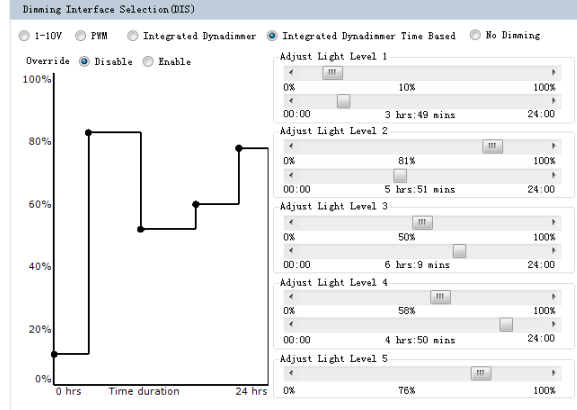

Allow users to separate 24hrs into 5 sections and corresponding output current.

#### ■ No Dimming



The driver will be in constant output mode.

### ■ Mechanical Specification

Dimensions(Unit:mm)

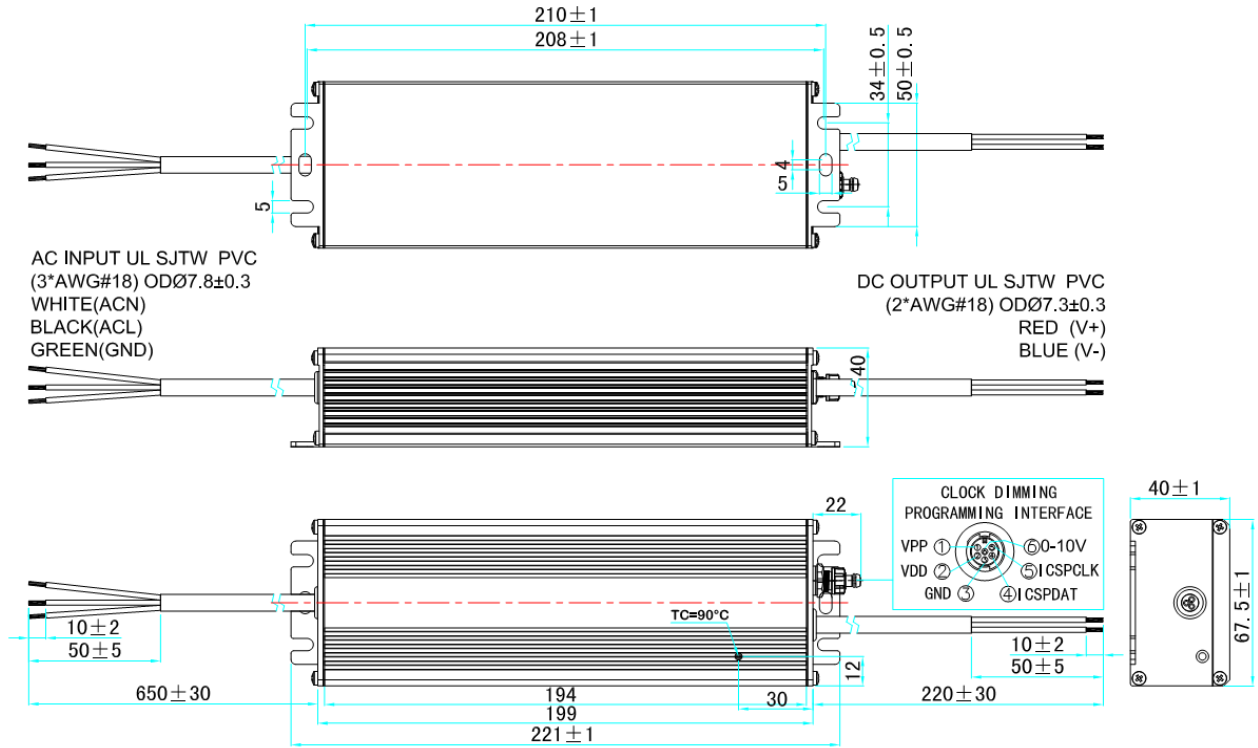

RoHS Compliance:

Our products comply with the European Directive 2002/95/EC, calling for the elimination of lead and other hazardous substances from electronic products.